

Operating Instruction

EXIOS

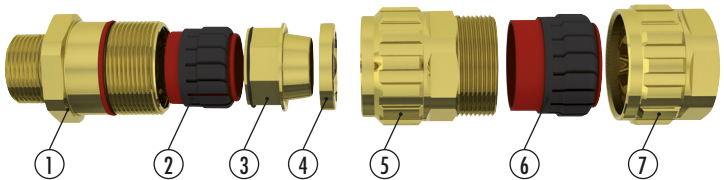

1. Entry Component
2. Inner Sheath Sealing
3. Interlocking Armour Cone
4. Armour Clamping Ring
5. Gland Body
6. Outer Sheath Sealing
7. Dome Nut

Operating temperature range	-60 °C – +105 °C
Protection	Type rating 4/4X/6 / IP 66, 67, 68 (5 bar)

Certification Details: EXIOS

II 2G Ex d e IIC Gb / II 1D Ex ta IIIC Da

IECEX: BVS 10.0078X

ATEX: BVS 10ATEXE062X

Class I, Div 2, ABCD; Class II, Div 1 & 2, EFG

Class I, Zone 1, AEx de IIC Gb; Zone 20, AEx ta IIIC, T125 °C Da

CSA: 12.2557737X

DIN EN IEC 60079-0 : 2019

DIN EN IEC 60079-1 : 2014

DIN EN IEC 60079-7 : 2015 / A1:2018

DIN EN IEC 60079-31 : 2014

DIN EN IEC 60529

EU Directive 2014/34/EU

HUMMEL AG

Lise-Meitner-Straße 2
79211 Denzlingen / Germany
Tel. +49 (0) 76 66 / 911 10-0
info@hummel.com

STEP 1

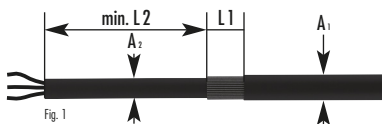

The cable is to be prepared as shown in Fig. 1. Measurements L1 and L2 should be kept to. Measurement L1 can be read off in Table 1. Choose measurement L2 depending on the installation. The inner cable sheathing must be free of damage and should extend beyond the cable gland.

STEP 2

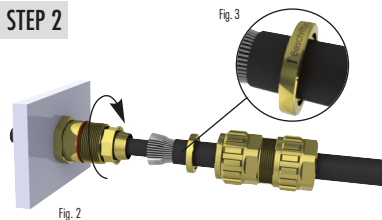

The cable gland is delivered with 2 armour clamping rings. Choose the appropriate clamping ring as per Table 1; the other one must not be used. After that, prepare the installation as in Fig. 2. Care should be taken with the correct installation of the clamping ring, Fig. 3.

ⓘ Recommended torque only refer to inspection specifications acc. to listed standards. Individual torques may differ due to type and character of the cable.

STEP 3

Install the entry component on the device or housing in question (~ 15 Nm). The end-user is responsible for ensuring that, at the point of installation, the adapter for the entry component has been made ready in accordance with Regulations. The entry component can be provided with a locknut to keep it from working loose.

Table 1

Size	AG		Armour Acceptance Range \varnothing mm					L1 mm	Nm	
	M	NPT	\varnothing mm	\varnothing mm A1	\varnothing mm A2	Ring I	Ring II			Ring III (optional)
20-1	M 16	3/8"	22	6-12	3-8,1	0,0-0,7	0,7-1,25	-	20	8
	M 20									
20-2	M 20	1/2"	24	9-16	6-12	0,0-0,7	0,7-1,25	-	20	8
20-3	M 20	1/2"	30	12,5-20,5	9-14	0,0-0,7	0,7-1,4	-	20	12
	M 25									
25	M 25	3/4"	36	16,9-26	12,5-20,5	0,0-0,7	0,9-1,6	0,7-1,4	20	18
32	M 32	1"	46	22-33	16,9-26	0,0-0,7	1,3-2,0	0,7-1,4	30	30
40	M 40	1 1/4"	55	28-41	22-33	0,0-0,7	1,3-2,0	0,7-1,4	30	50
		1 1/2"								
50	M 50	2"	65	36-52,6	28,9-44,4	0,0-1,0	1,5-2,5	1,0-2,0	35	60
63	M 63	2 1/2"	80	46-65,3	39,9-56,3	0,0-1,0	1,5-2,5	1,0-2,0	40	65
75	M 75	3"	95	57-78	50,5-68,2	0,0-1,0	1,5-2,5	1,0-2,0	45	135

Installation conditions - through hole (only Ex-e)

The cable gland must be fixed with a lock nut

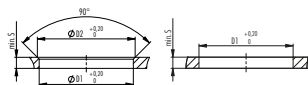

Thread	D1	D2	S
M6x1	6	7,3	2,5
M8x1,25	8	9	2,5
M10x1,5	10	10,4	2,5
M12x1,5	12	13	2,5
M16x1,5	16	17	2,5
M20x1,5	20	21	2,5
M25x1,5	25	26	2,5
M32x1,5	32	33	2,5
M40x1,5	40	41	2,5
M50x1,5	50	51	2,5
M63x1,5	63	64	2,5
M75x1,5	75	76	2,5
M80x2	80	81	4
M90x2	90	91	5
M100x2	100	101,3	5
M110x2	110	111	5

Installation conditions - thread

For all thread sizes the thread tolerance is 6g

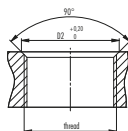

Thread	D1	D2	S
Pg7	12,7	13,2	2,5
Pg9	15,4	15,9	2,5
Pg11	18,8	19,3	2,5
Pg13,5	20,7	21,2	2,5
Pg16	22,8	23,3	2,5
Pg21	28,6	29,1	3
Pg29	37,4	38,4	3
Pg36	47,5	48,5	3
Pg42	54,5	55,5	3
Pg48	59,8	60,8	3

Thread	D1	D2	S
NPT 3/8"	17,3	18	4
NPT 1/2"	21,1	22	5
NPT 3/4"	26,7	27,5	4
NPT 1"	34,3	35	4
NPT 1 1/4"	41,9	42,5	5
NPT 1 1/2"	48,8	49,5	5
NPT 2"	61,1	62,0	5
NPT 2 1/2"	74,0	76,5	6
NPT 3"	89,8	92,5	6

D1: through hole

D2: countersink

If the cable gland is used in a way that deviates from the specified installation conditions, the user must ensure the safety of the system.

STEP 4

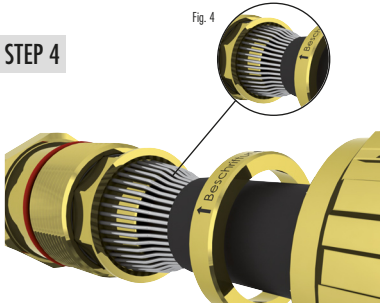

Position the armour of the cable so that all parts of the armour are in contact with the armour cone (Fig. 4) and the ends of the armour touch the edge of the armour cone.

Now screw the gland body hand-tight on the entry component. It helps if, while doing so, the cable is pushed slightly in towards the device or housing. Finally, with the appropriate open-ended spanner, tighten roughly 1/2 a turn in order to securely clamp the armour.

STEP 5

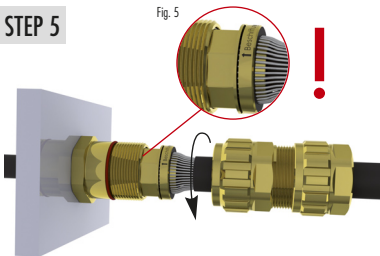

After that, loosen the gland body and check for correct seating of the armour (Fig. 5). The armour must be firmly clamped. If need be, repeat step 4. The o-ring on the armour cone is only for ease of installation. Damage or removal does not affect the function of the gland.

STEP 6

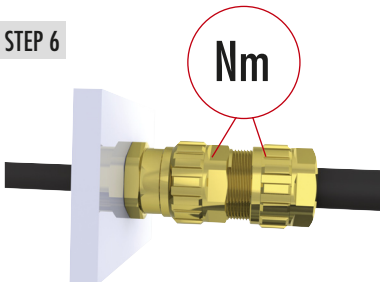

After the entry component and the gland body have been screwed up again as per Step 4 (Nm), the dome nut can now be tightened. To speed up assembly, it can be tightened by hand to start with. Then tighten up using an open-ended spanner (Nm).

General information:

- The max. surface roughness of the device or housing cannot exceed Rz 16.
- The sealing surface of the cable gland must always be mounted at right angle to the housing or device surface.
- The installation of earhtags is only permitted on the sealing surface between the housing and the cable gland. The user has to ensure the tightness with regard to IP and explosion protection.
- If an EMC connection of the device / cable gland is provided, the housing material must consist of conductive material. If this conductive material is coated with a non-conductive material, a special EMC lock nut must be used. There are no further restrictions of the housing material.
- Sealing method: The sealing at the cable is done by the sealing insert. Sealing at the housing is done by an O-ring.
- Our metric-size cable glands are provided as standard with an O-ring on the connecting thread.
- Before initial operation of the facilities, the assembly is to be checked to see that it conforms to these installation instructions, to the applicable national and international standards, as well as those applicable to the use in question.
- Suitable tools must be used for the assembly; furthermore, the installation may only be carried out by qualified electricians or by trained staff.
- Any modification which differs from the condition as delivered is not permitted.
- In order to fulfill explosion protection type Ex d, the cable used must be round and compact, the cables must also take into consideration in particular the Regulations as per IEC 60079-14 Section 9.3. Observe the Regulations of IEC 60079-14 on direct insertion into the Ex d area.
- At the specified maintenance intervals it is recommended to check the compression fittings and tighten as necessary.
- The use of non-armoured cables or alternatively the use of cables with shielding braid is only permitted for permanently installed power lines (25 %).
- In the case of NPT connecting threads, the end-user must ensure that the necessary IP protection is guaranteed; this can be done using a suitable thread sealing agent.
- When installing the cable gland through bore holes, care should be taken that the maximum diameters are not exceeded.
- The cable glands are provided with a sealing ring with an axial sealing height of at least 5 mm. With reference to the clearance groove, the end-user should ensure that at least five complete turns of the connector thread are made. In order to guarantee a screw depth of 8 mm, the enclosure should have a wall thickness of min. 10 mm ; if < 10 mm, then if necessary, use a washer when cable entries are attached to the flameproof enclosure.
- When determining the temperature ranges of the device in the dust Ex-area, the Regulations of EN 60079-0 and EN 60079-31 must be taken into consideration.

EU Declaration of Conformity

issued under the sole responsibility of the manufacturer – Complying the EU Directive 2014/34/EU, Attachment X

Types	Cable Glands EXIOS, EXIOS MZ
Certified in Type Examination certificates	BVS 10 ATEX E 062X
Issued by notified body	Dekra Testing and Certification GmbH Dinnendahlstraße 9 44809 Bochum / Germany
ID number	0158
Following standards are applied	
EN 60079-0 : 2019	Electrical apparatus for potentially Flameproof enclosure – General requirements
EN 60079-1 : 2014	Electrical apparatus for potentially explosive atmospheres – Increased safety „d“
EN 60079-7 : 2015 / A1:2018	Electrical apparatus for potentially explosive atmospheres – Increased safety „e“ (marking excluded)
EN 60079-31 : 2014	Electrical apparatus for use in the presence of combustible dust, Electrical apparatus protected by enclosures – Construction and testing
EN 60529	Degrees of protection provided by enclosures (IP-Code)

We declare that the above articles were developed and manufactured in the responsibility of HUMMEL AG.



Michael Nörr
HUMMEL AG / CEO