

SFE Outflow valves drinking water

Item number 2705120000

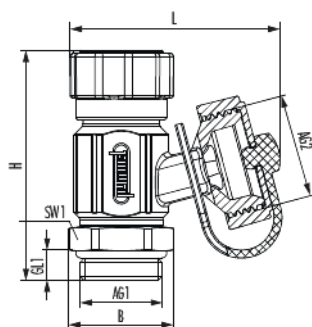

Technical data

Connection size 1 (AG1)	G 1/2
Connection size 2 (AG2)	G 3/4
Connection type 1 (AT1)	External thread
Connection type 2 (AT2)	Hose connection
Length (L)	53.4 mm
Width (B)	26.5 mm
Height (H)	58.3 mm
Thread Length 1 (GL1)	7.5 mm
Wrench size 1 (SW1)	24 mm
Colour	black
Material moulded seal	EPDM
Material plastic cap	PA
Material body/spindle	Brass blank
Material retaining strap	PE
Material spindle	Brass blank

SFE Outflow valves drinking water

Item number 2705120000

Material	Brass blank
Max. operating pressure	10 bar
Max. operating temperature heating	90 °C

Commercial data

Packaging Unit	10
EAN code	4033878011379
Weight	0.0799 kg
ETIM 7	EC010071
ETIM 8	EC010071
ETIM 9	EC010071
eCl@ss 10.1	22-39-04-11
Customs tariff number	84818039

Note:

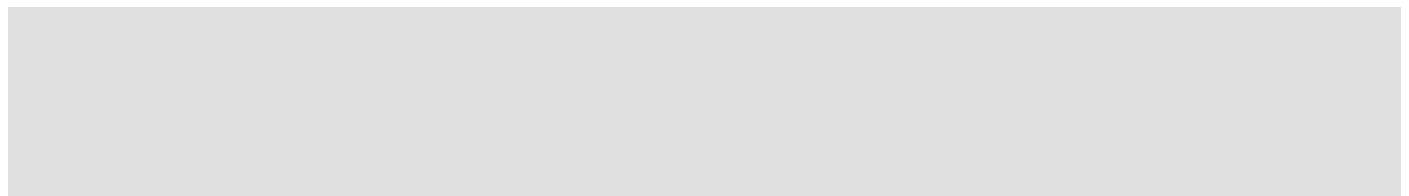

SFE Outflow valves drinking water

Item number 2705120000