

# Housing INOX cable connector M23 Signal

Item number 7140600000

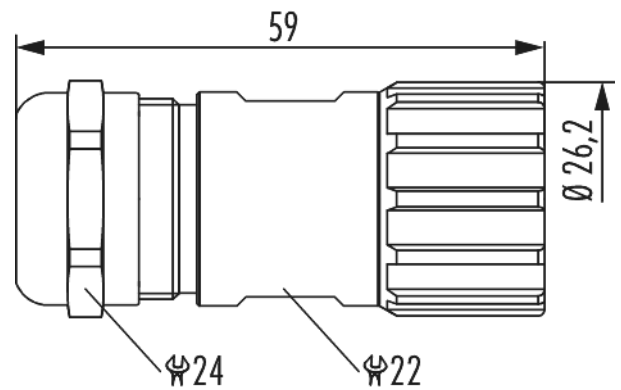

## Technical data

Housing type	Cable
Material housing	Stainless steel 1.4404 (AISI 316)
Material housing surface	-
Insert	Socket
Version	Screw
External thread plug-in side	-
Internal thread plug-in side	M23 x 1
Knurled nut-Ø plug-in side	26.2 mm
Locking type	Screw
Shield	
Seal type	O-Ring
Material seals/o-rings	FKM (FPM)
Coding position	
Panel hole	- mm
Drill form	- mm
Wall thickness	- mm

# Housing INOX cable connector M23 Signal

Item number 7140600000

<b>Chamfer</b>	
<b>Flange</b>	- mm
<b>Hole diameter</b>	- mm
<b>Allen key/Torx</b>	-
<b>Wrench size (SW1/SW2)</b>	24/22 mm
<b>Cable diameter</b>	10 - 14 mm
<b>Temperature range</b>	-40°C to +125°C
<b>Protection class</b>	IP 67 , IP 69 K

# Housing INOX cable connector M23 Signal

Item number 714060000

## Commercial data

Packaging Unit	5
EAN code	4033878502952
Weight	0.09344 kg
ETIM 7	EC003556
ETIM 8	EC003556
ETIM 9	EC003556
eCl@ss 10.1	27440224
Customs tariff number	85366990

Note:

