

Housing panel connector M23 Signal

Item number 745400000

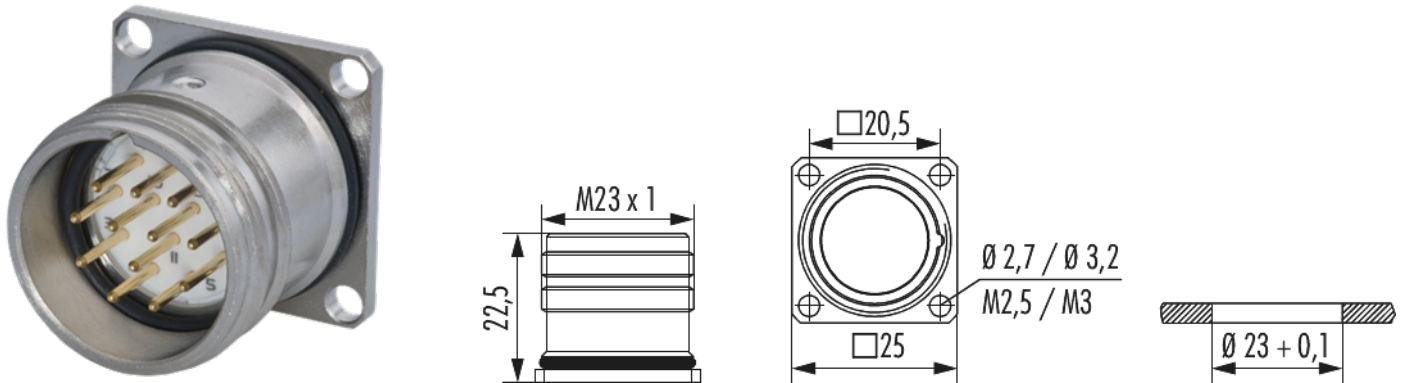

Technical data

Material housing	Copper-Zinc alloy
Material housing surface	Nickel
Installation type	Rear wall
External thread plug-in side	M23 x 1
Locking type	Screw
Shield	unshielded
Material seals/o-rings	NBR
Coding position	
Panel hole	$\varnothing 23 + 0,1 \text{ mm}$
Drill form	- mm
Flange	25 x 25 mm
Hole distance	20.5 mm
Hole diameter	4 x $\varnothing 2,7 \text{ mm}$
Allen key/Torx	-
Protection class	IP 67 , IP 69 K
Temperature range	-40°C to +125°C



Housing panel connector M23 Signal

Item number 745400000

Commercial data

Packaging Unit	25
EAN code	4033878503638
Weight	0.02497 kg
ETIM 7	EC003556
ETIM 8	EC003556
ETIM 9	EC003556
eCl@ss 10.1	27440224
Customs tariff number	85366990

Note:

