

Housing panel connector M23 Signal radius

Item number 7490000000

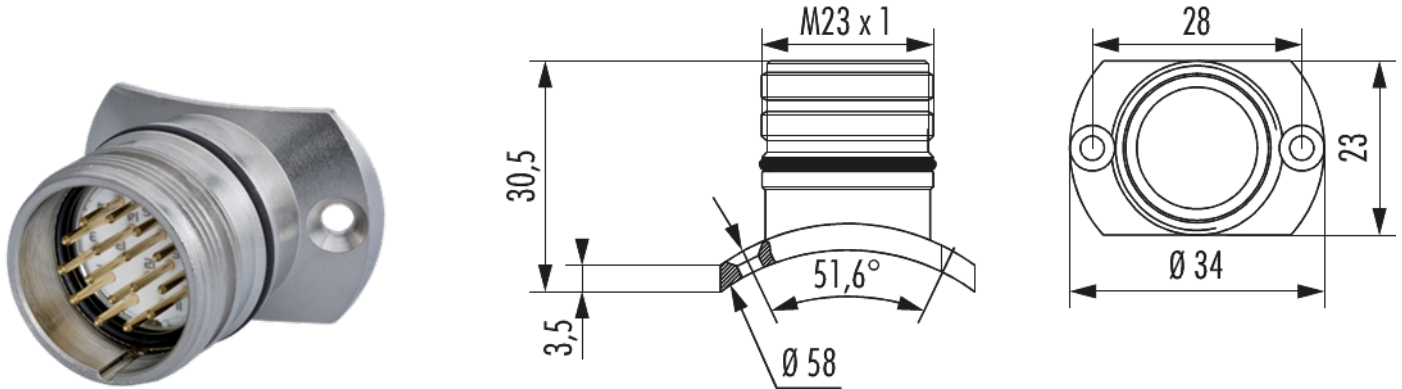

Technical data

Material housing	Copper-Zinc alloy
Material housing surface	Nickel
Version	with vibration protection
External thread plug-in side	M23 x 1
Locking type	Screw
Shield	unshielded
Material seals/o-rings	NBR
Coding position	
Protection class	IP 67 , IP 69 K
Temperature range	-40 °C to +125 °C



Housing panel connector M23 Signal radius

Item number 7490000000

Commercial data

Packaging Unit	25
EAN code	4033878503782
Weight	0.03517 kg
ETIM 7	EC003556
ETIM 8	EC003556
ETIM 9	EC003556
eCl@ss 10.1	27440224
Customs tariff number	85366990

Note:

