

Housing incl. insert cable connector M40

Power - 6-pole

Item number 7710823000

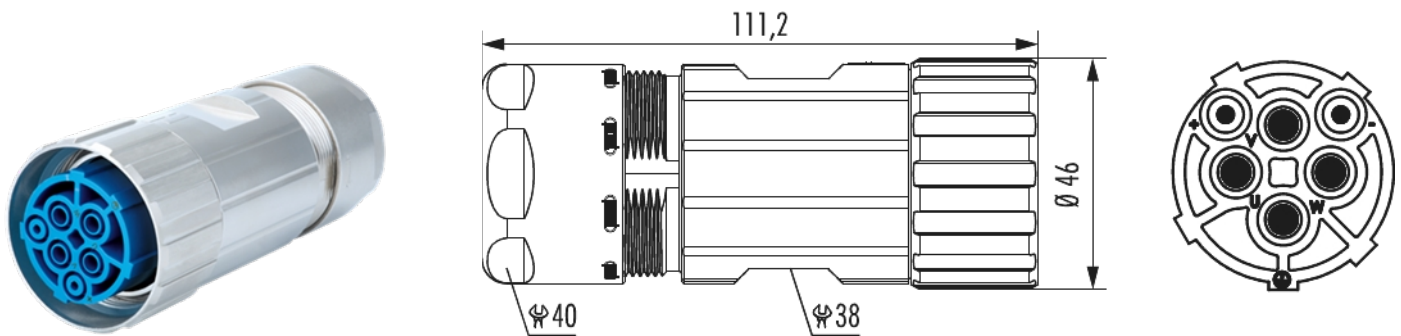

Technical data

Housing type	Cable
Material housing	brass , Zinc Die Cast
Material housing surface	Nickel
Insert	Socket
Version	Screw
External thread plug-in side	-
Internal thread plug-in side	M40 x 1,5
Knurled nut-Ø plug-in side	46 mm
TWILOCK thread	-
Locking type	Screw
Shield	shielded
Seal type	O-Ring
Material seals/o-rings	FKM (FPM) , NBR
Wrench size (SW1/SW2)	40/38 mm
Cable diameter	21 - 28 mm
Length (L)	111.2 mm



Housing incl. insert cable connector M40

Power - 6-pole

Item number 7710823000

Temperature range	-40 °C to +125 °C
Degree of Protection	3
Protection class	IP 67 , IP 69 K
Characteristic of connection	Crimp
Number of poles	6
Pole picture	2 + 3 + PE
Color contact insert	blue
Material insulating body	PBT
Material Ethernet insert	-
Number of contacts signal	2
Number of contacts power	3
Number of contacts PE	1
Contact-Ø signal	2 mm
Contact-Ø power	3.6 mm
Terminal cross section data	-
Terminal cross section signal	0,14 - 1,5 mm ²
Terminal cross section power	2,5 - 16 mm ²
Crimp range	0.14 - 16 mm ²
Nominal current signal	28 A
Nominal current power	55 A
Nominal voltage at degree of pollution 3 signal	300 V~
Nominal voltage at degree of pollution 3 power	600 V~
Test voltage signal	2500 V~



Housing incl. insert cable connector M40

Power - 6-pole

Item number 7710823000

Test voltage power	4000 V~
Insulation resistance signal	> 10 ¹³
Insulation resistance power	> 10 ¹³
max. contact resistance signal	3 mOhm
max. contact resistance power	1 mOhm
Minimum mating cycles	> 500
Suitable data contacts	-
Suitable Signal contacts	7015952002
Suitable power contacts	7015953602 , 7015953612 , 7015953622 , 7015953624 , 7015953632
Suitable PE-/FE-contacts	7015953602 , 7015953612 , 7015953622 , 7015953624 , 7015953632



Housing incl. insert cable connector M40

Power - 6-pole

Item number 7710823000

Commercial data

Packaging Unit	5
EAN code	4033878504307
Weight	0.342 kg
ETIM 7	EC002635
ETIM 8	EC002635
ETIM 9	EC002635
eCl@ss 10.1	27440102
Customs tariff number	85366990

Note:

