

Housing panel connector M23 RJ45 solder in

Item number 7R40082000

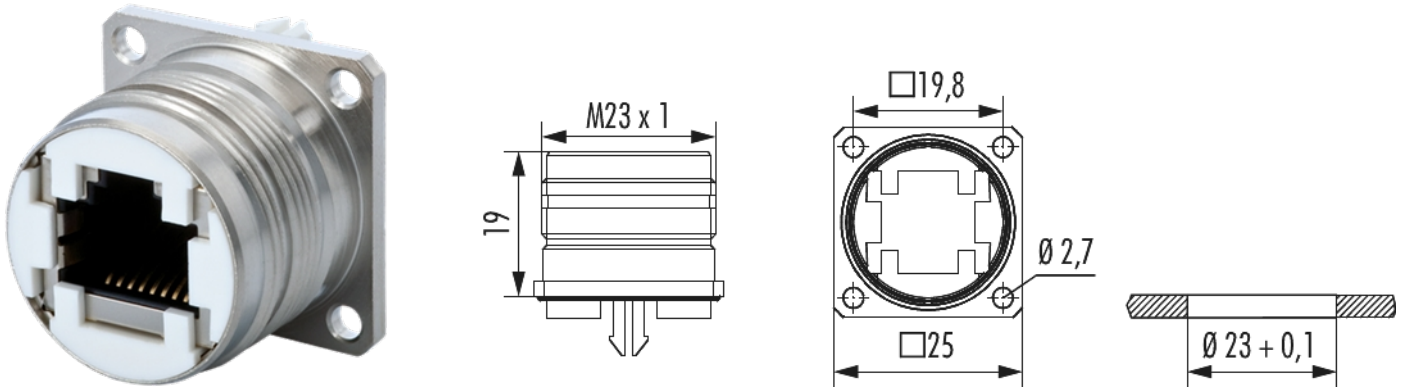

Technical data

Material housing	brass , Zinc Die Cast
Material housing surface	Nickel
Insert	RJ45
Installation type	Front wall
Version	-
External thread plug-in side	M23 x 1
Internal thread plug-in side	-
Locking type	Screw
Shield	unshielded
Seal type	O-Ring
Material seals/o-rings	FKM (FPM) , NBR
Coding position	
Panel hole	Ø 23 + 0,1 mm
Drill form	- mm
Flange	25 x 25 mm
Hole distance	19.8 mm

Housing panel connector M23 RJ45 solder in

Item number 7R40082000

Hole diameter	4 x Ø 2,7 mm
Length (L)	19 mm
Allen key/Torx	-
Protection class	IP 67 , IP 69 K
Temperature range	-40°C to +125°C
suitable contact inserts	7MRJ450007 , A7RJ-081M41 , A7RJ-081M6A , A7RJ-821M51

Housing panel connector M23 RJ45 solder in

Item number 7R40082000

Commercial data

Packaging Unit	25
EAN code	4033878505090
Weight	0.0552 kg
ETIM 7	EC003556
ETIM 8	EC003556
ETIM 9	EC003556
eCl@ss 10.1	27440224
Customs tariff number	85366990

Note:

