

# Housing cable connector M12 Power - K, L

Item number A712-7K1050000

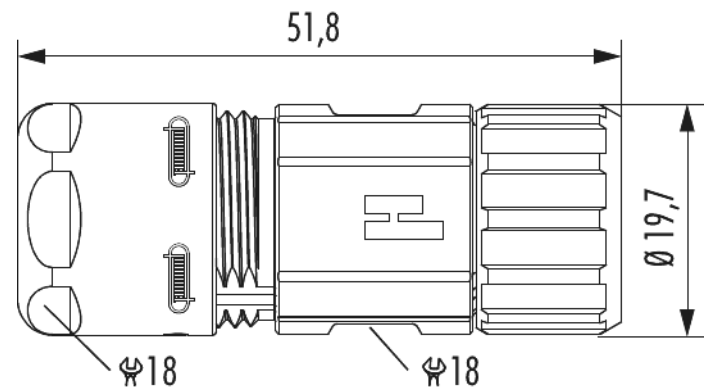

## Technical data

Housing type	Cable
Material housing	brass , Zinc Die Cast
Material housing surface	Nickel
Coding	K , L
Version	Screw
Internal thread plug-in side	M12 x 1
Knurled nut-Ø plug-in side	19.7 mm
Locking type	Screw
Shield	shielded
Material seals/o-rings	HNBR , NBR
Wrench size (SW1/SW2)	18/18 mm
Cable diameter	8 - 11 mm
Temperature range	-40°C to +125°C
Protection class	IP 67 , IP 69 K
suitable contact inserts	A712-7K03941102 , A712-7L03941102



# Housing cable connector M12 Power - K, L

Item number A712-7K1050000

## Commercial data

Packaging Unit	5
EAN code	4033878505311
Weight	0.05469 kg
ETIM 7	EC003556
ETIM 8	EC003556
ETIM 9	EC003556
eCl@ss 10.1	27440224
Customs tariff number	85366990

## Note:

max. operating temperature at max. operating time: + 100 ° C at 20 000h / / + 125 ° C at 600h

