

Housing coupler connector M12 Power - K, L

Item number A712-7K2030000

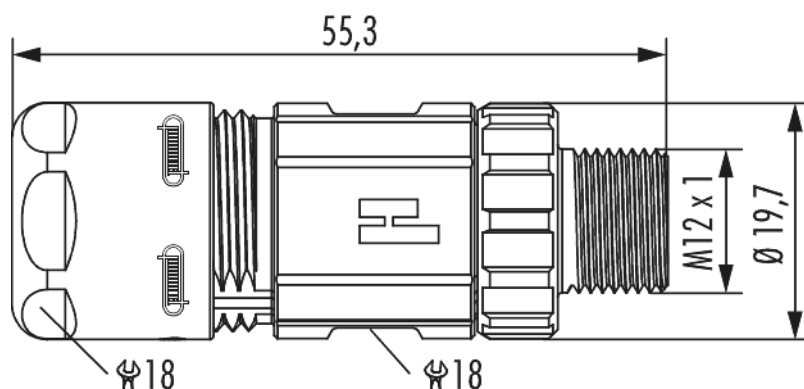

Technical data

Housing type	Coupler
Material housing	brass , Zinc Die Cast
Material housing surface	Nickel
Coding	K , L
Version	Screw
External thread plug-in side	M12 x 1
Knurled screw-Ø plug-in side	19.7 mm
Locking type	Screw
Shield	shielded
Material seals/o-rings	HNBR , NBR
Wrench size (SW1/SW2)	18/18 mm
Cable diameter	3 - 6 mm
Temperature range	-40°C to +125°C
Protection class	IP 67 , IP 69 K
suitable contact inserts	A712-7K03941101 , A712-7L03941101



Housing coupler connector M12 Power - K, L

Item number A712-7K20300000

Commercial data

Packaging Unit	5
EAN code	4033878505328
Weight	0.04819 kg
ETIM 7	EC003556
ETIM 8	EC003556
ETIM 9	EC003556
eCl@ss 10.1	27440224
Customs tariff number	85366990

Note:

max. operating temperature at max. operating time: + 100 ° C at 20 000h / / + 125 ° C at 600h

